

MAGALU



MAG^oALU

Magnetische Aluminium-Stecknussschienen

- Leicht und kompakt
- Magnetisch, kein Verschrauben
- Korrosionsbeständig
- Es können individuelle Sätze zusammenstellt werden
- Klammern/Nüsse 1/4", 3/8", 1/2" auf der gleichen Schiene kombinierbar

Rails magnétiques pour douilles en aluminium

- Léger et compact
- Magnétique, pas besoin de vis
- Résistant contre la corrosion
- Possibilité de composer des jeux personnalisés
- Possibilité de combiner des clips/douilles 1/4", 3/8", 1/2" sur le même rail

Binario porta bussole in alluminio magnetizzato

- Leggero e compatto
- Magnetico non necessita di viti
- Resistente alla corrosione
- Possibilità di combinare a scelta l'assortimento di bussole
- Possibilità di abbinare sullo stesso supporto diverse tipologie di clip da 1/4", 3/8", 1/2"

Magnetic aluminium socket rail

- Lightweight and compact
- Magnetic, no fixing by screws
- Corrosion-resistant
- You can combine your individuel socket-composition
- Clips/sockets 1/4", 3/8", 1/2" can be combined on the same rail

Regleta magnética de aluminio para vasos

- Ligera y compacta
- Magnética, no necesita tornillos
- Resistente a la corrosión
- Puede realizar su composición individual de vasos
- Posibilidad de combinar en la misma regleta clips/vasos de 1/4", 3/8", 1/2"

Suporte magnetico em aluminio para chaves

- Leve e compacto
- Magnetico, sem parafusos de fixação
- Resistente a corrosão
- Pode fazer voce a sua composição individual de chaves
- Clips/Chaves 1/4", 3/8", 1/2" podem ser combinadas no mesmo suporte

Dopsleutel magneethouder

- Licht en compact
- Magnetisch, dus schroefloze bevestiging
- Roestwerend
- Bepaal uw eigen doppensamenstelling
- Doppen van 1/4", 3/8" en 1/2" kunnen worden gecombineerd op dezelfde rail

Magnetisk aluskinne til toppe

- Let og kompakt
- Magnetisk, ingen brug af skruer
- Korrosionsbestandig
- Individuelle kombinationsmuligheder
- 1/4", 3/8", 1/2" toppe kan kombineres på samme skinne

MAGNETIC

INDIVIDUAL

KW SYSTEM

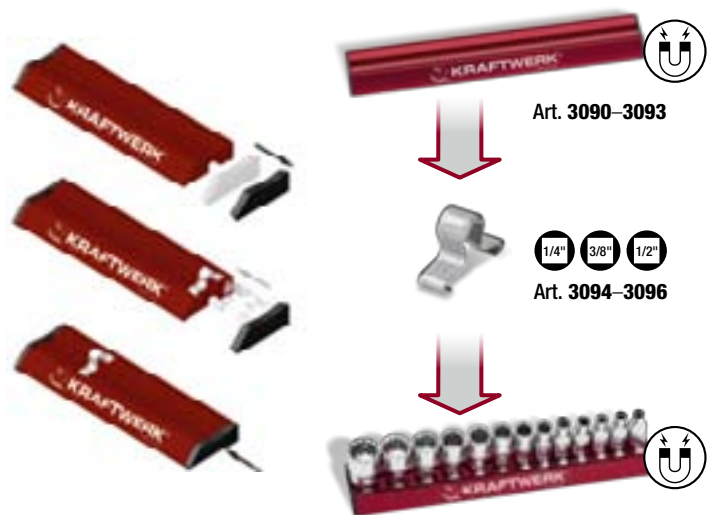

Art.	L mm		
3090	115	1/4" - 3/8" - 1/2"	
3091	185	1/4" - 3/8" - 1/2"	
3092	240	1/4" - 3/8" - 1/2"	
3093	300	1/4" - 3/8" - 1/2"	



Art.			
3094	1/4"	10	
3095	3/8"	10	
3096	1/2"	10	

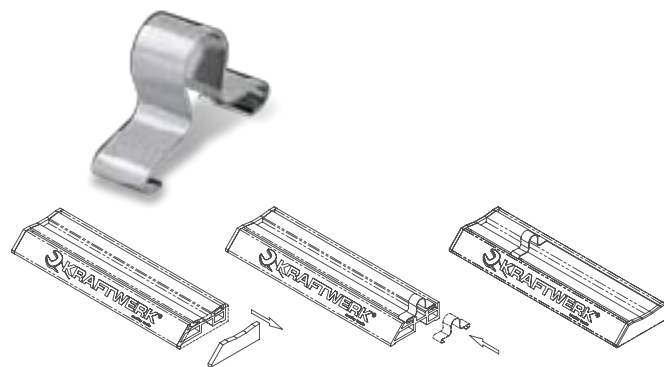

Art.	L mm	
101990	50	

1/4"

12 PCS

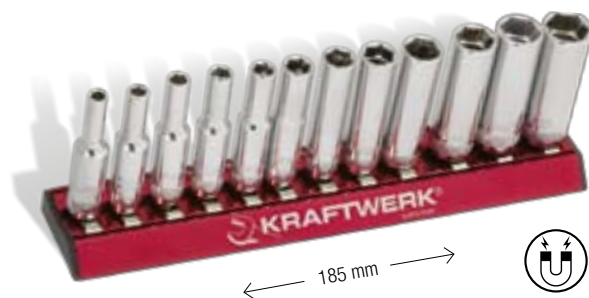

Art.	L mm	
201990	64	

3/8"

11 PCS



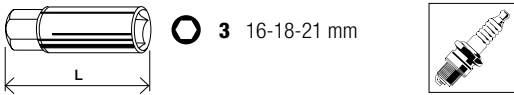

3 16-18-21 mm

Art.	L mm
201998	16 = 64
	18 = 65
	21 = 70



3/8"

3 PCS

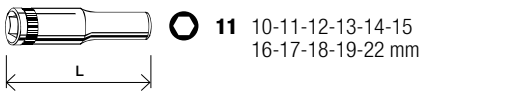

11 10-11-12-13-14-15
16-17-18-19-22 mm

Art.	L mm
301990	77



1/2"

11 PCS

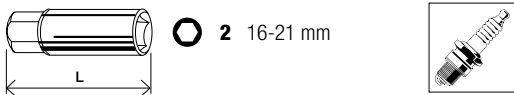

2 16-21 mm

Art.	L mm
301998	16 = 64
	21 = 70



1/2"

2 PCS

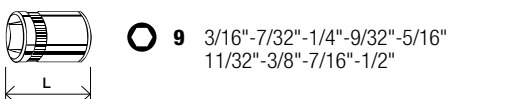

9 3/16"-7/32"-1/4"-9/32"-5/16"
11/32"-3/8"-7/16"-1/2"

Art.	L mm
100599	25



1/4"

9 PCS

inch



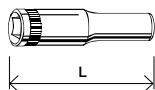

○ 9 3/16"-7/32"-1/4"-9/32"-5/16"
11/32"-3/8"-7/16"-1/2"

Art.	L mm
101599	50



1/4"

9
PCS

inch



○ 12 5/16"-3/8"-7/16"-1/2"-9/16"-5/8"
11/16"-3/4"-13/16"-7/8"-15/16"-1"

Art.	L mm
200599	25



3/8"

12
PCS

inch

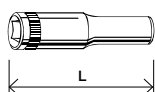

○ 7 3/8"-7/16"-1/2"-9/16"
11/16"-3/4"-7/8"

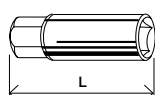

○ 2 5/8"-13/16"



Art.	L mm
201599	64



3/8"

9
PCS

inch



mm 4-4.5-5-5.5-6-7-8-9
10-11-12-13-14 mm

TX E5-E6-E8-E10-E12
E14-E16-E18

inch 5/32"-7/32"-1/4"-5/32"-5/16"
11/32"-3/8"-7/16"-15/32"-1/2"

XZN M5-M6-M8-M9-M10
M12-M14-M16-M18

COMBI **ALL IN**



○ 13 4-4.5-5-5.5-6-7-8-9
10-11-12-13-14 mm

Art.	L mm
130990	25



1/4"

13
PCS



mm 10-11-12-13-14-15
16-17-18-19 mm

TX E12-E14-E16-E18
E-20-E22-E24

inch 3/8"-7/16"-15/32"-1/2"
19/32"-5/8"-3/4"

XZN M12-M14-M16-M18

COMBI ALL IN ONE

 **10** 10-11-12-13-14-15
16-17-18-19 mm



Art.	L mm
330990	38

1/2"

10
PCS



mm 20-21-22-24-27-30-32 mm

TX E26-E28-E30-E34-E38-E40

inch 25/32"-13/16"-7/8"-15/16"
1-1/16"-1-3/16"-1-1/4"

COMBI ALL IN ONE

 **7** 20-21-22-24-27-30-32 mm



Art.	L mm
330991	42

1/2"

7
PCS



 **7** E4-E5-E6-E7-E8-E10-E11

COMBI ALL IN ONE

Art.	L mm
120099	25

1/4"

7
PCS

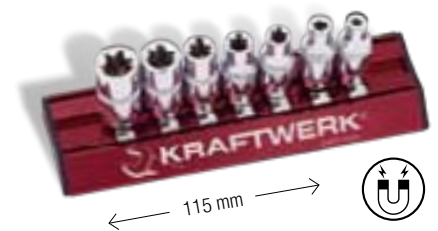

 **12** E4-E5-E6-E7-E8-E10-E11
E12-E14-E16-E18-E20

COMBI ALL IN ONE

Art.	L mm
220099	28

3/8"

12
PCS



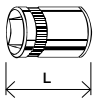

8 E10-E12-E14-E16-E18-E20-E22-E24

Art.	L mm
320099	40



1/2"

8
PCS

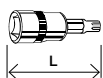

10 T08-T10-T15-T20-T25-T27-T30-T40

Art.	L mm
105099	38



1/4"

S2
quality

8
PCS

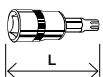
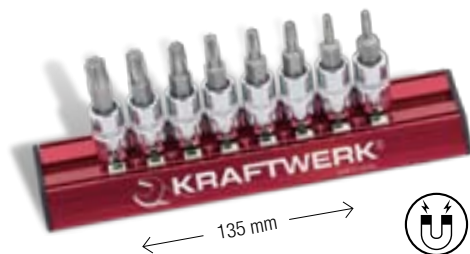

11 T10-T15-T20-T25-T27-T30
T40-T45-T50-T55-T60

Art.	L mm
205099	48



3/8"

S2
quality

11
PCS

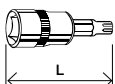

11 T10-T15-T20-T25-T27-T30
T40-T45-T50-T55-T60

Art.	L mm
205399	48



3/8"

S2
quality

11
PCS



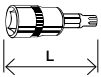

12 T10-T15-T20-T25-T27-T30
T40-T45-T50-T55-T60-T70

Art.	L mm
325099	56



1/2"

S2 quality

12 PCS

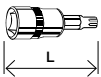
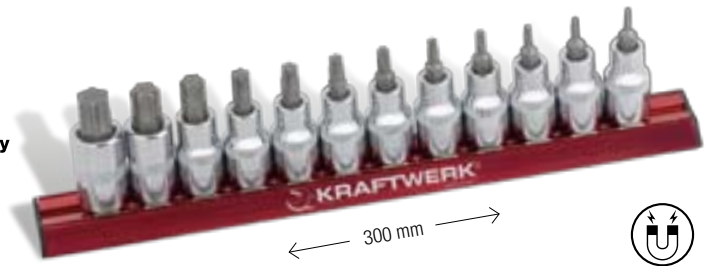

1/4" 7 T08-T10-T15-T20-T25-T27-T30
1/2" 6 T40-T45-T50-T55-T60-T70

Art.	L mm
99045	1/4" = 38 1/2" = 56



1/4"

1/2"

13 PCS

S2 quality

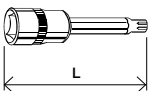

10 T10-T15-T20-T25-T27
T30-T40-T45-T50-T55

Art.	L mm
335099	100



1/2"

S2 quality

10 PCS

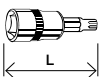

9 TS8-TS9-TS10-TS15-TS20
TS25-TS27-TS30-TS40
5-TX

Art.	L mm
115099	38



1/4"

S2 quality

9 PCS

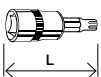

9 TS8-TS9-TS10-TS15-TS20
TS25-TS27-TS30-TS40
5-TX

Art.	L mm
115399	38



1/4"

S2 quality

9 PCS



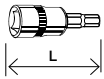

6 3-4-5-6-7-8 mm

Art.	L mm
106099	38



1/4"

S2 quality

6 PCS

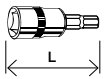
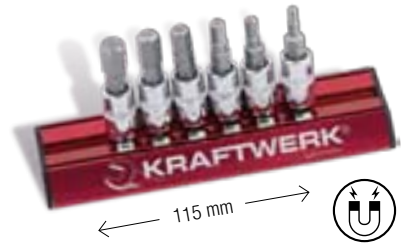

7 3-4-5-6-7-8-10 mm

Art.	L mm
206099	48



3/8"

S2 quality

7 PCS

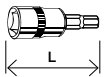

8 5-6-7-8-10-12-14-17 mm

Art.	L mm
326099	55



1/2"

S2 quality

8 PCS

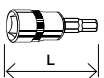

1/4" 5 3-4-5-6-7 mm
1/2" 5 8-10-12-14-17 mm

Art.	L mm
99046	1/4" = 38 1/2" = 56



1/4"

1/2"

10 PCS

S2 quality





○ 6 5-6-7-8-10-12 mm

Art.	L mm
336099	100



1/2"

S2 quality

6 PCS

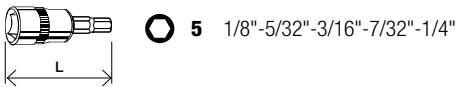

○ 5 1/8"-5/32"-3/16"-7/32"-1/4"

Art.	L mm
106599	38



1/4"

S2 quality

5 PCS

inch



○ 7 1/8"-5/32"-3/16"-7/32"
1/4"-5/16"-3/8"

Art.	L mm
206599	48



3/8"

S2 quality

7 PCS

inch

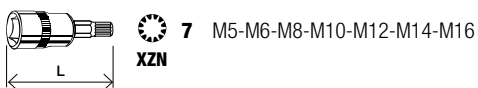

○ XZN 7 M5-M6-M8-M10-M12-M14-M16

Art.	L mm
328099	55



1/2"

S2 quality

7 PCS



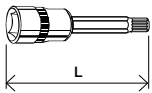

5 M5-M6-M8-M10-M12
XZN

Art.	L mm
338099	100



1/2"

S2
quality

5
PCS

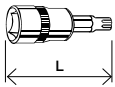

10 M5-M6-M7-M8-M9-M10
M11-M12-M13-M14

Art.	L mm
329099	55



1/4"

S2
quality

10
PCS

RIBE

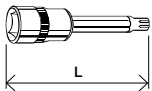

10 M5-M6-M7-M8-M9-M10
M11-M12-M13-M14

Art.	L mm
339099	100



1/2"

S2
quality

10
PCS

RIBE

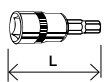

7 8-9-10-12-13-14-17 mm
7 7-8-9.5-10.5-12-13.1-14 mm

M16

1 10 mm

Art.	L mm
30010	35



3/8"

17
PCS



3 17-19-21 mm

Art.	L mm
381099	85



1/2"

3
PCS

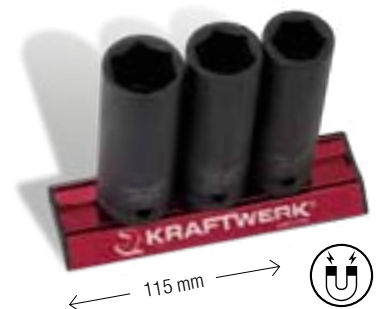

Art.		L mm
3200	1/4"	145
3210	3/8"	205
3220	1/2"	255

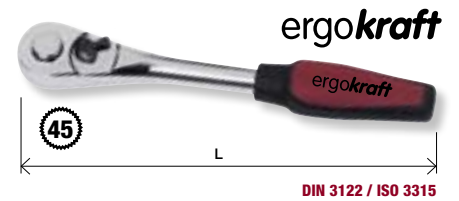

DIN 3122 / ISO 3315

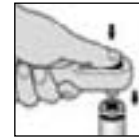

Art.		L mm
4009	1/4"	145
4019	3/8"	210
4029	1/2"	245



DIN 3122 / ISO 3315

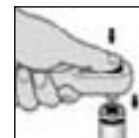

Art.		L mm
4000	1/4"	153
4010	3/8"	217
4020	1/2"	261



DIN 3122 / ISO 3315

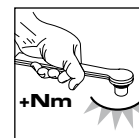





Art.		L mm
3206	1/4"	143
3216	3/8"	205
3226	1/2"	260







DIN 3122 / ISO 3315





Art.		L mm	
2000	1/4"	148 - 198	
2010	3/8"	215 - 315	
2020	1/2"	307 - 447	



Art.		L mm	
3207	1/4"	200	
3217	3/8"	255	
3227	1/2"	305	



Art.		L mm	
3227EX	1/2"	300 - 450	





A/S H. Sindby & Co.
Bommerhavevej 41, Sletde
DK-7100 Vejle
Tel: +45 75 88 21 22
Fax: +45 75 88 22 40
E-Mail: sindby@sindby.dk
Order: ordre@sindby.dk
Internet: www.sindby.dk



Clavis Tool GmbH
Pappelweg 6
DE-63741 Aschaffenburg
Tel: +49 6021 45704 0
Fax: +49 6021 45704 13
E-Mail: info@clavis-tool.de
Internet: www.clavis-tool.de



Harrems Tools B.V.
Labradordreef 6
NL-3565 AN Utrecht
Tel: +31 (0)30 265 03 21
Fax: +31 (0)30 262 64 24
E-Mail: info@harrems.nl
Internet: www.harrems.nl



Hosendorfer Ges.m.b.H.
Wodkigasse 7
AT-2353 Guntramsdorf/Wien
Tel: +43 (0)2236 53491
Fax: +43 (0)2236 52347
E-Mail: office@hosendorfer.at
Internet: www.kuma-werkzeuge.at



INTENSE s.r.l.
Via Novara 1
IT-20063 Cernusco Sul Naviglio (MI)
Tel: +39 02 921 8151
Fax: +39 02 921 04594
E-Mail: contact@intense.it
Internet: www.intense.it



000 Firma „InvestCentre“ (GmbH)
Leninsky Rayon, Mamyri 31
142704 Moskovskaya Oblast
Tel: +7 495 338 1809
Fax: +7 495 337 6192
E-Mail: potshta@inv-c.ru
Internet: www.inv-c.ru



Kova Tools Oy
Hallitie 3
FI-62100 Lapua
Tel: +358 010 666 4080
Fax: +358 06 433 5001
E-Mail: info@kovatools.com
Internet: www.kovatools.com



KVAIO SRL
Polona, 18
RO-7000 Otopeni-Bucuresti
Tel: +40 722 47 64 67
Fax: +40 723 19 67 54



Logey ehf heildverslun
Vesturvör 7
IS-200 Kópavogur
Tel: +0354 511 2055
Fax: +0354 511 2056
E-Mail: logey@logey.is
Internet: www.logey.is



PROFIKRAFT TRADING, s.r.o.
Bráfova 6
CZ-Brno 616 00
Tel: +420 541 249 260
Fax: +420 541 249 261
E-Mail: profikraft@profikraft.cz
Internet: www.profikraft.cz



Techno-Elit & Co. KG
Ithakis Str. 63
GR-18233 A.I.Rentis-Athen
Tel: +30 210 4900064
Fax: +30 210 4900072
E-Mail: info@techno-elit.gr
Internet: www.techno-elit.gr



Tecniverca-Máquinas Ferramentas, Lda
Estrada Municipal 1022, nº339
PT-2860-302 Pinhal de Areia-Moita
Tel: +351 219 584 273
Fax: +351 219 577 133
E-Mail: tecniverca@tecniverca.pt
Internet: www.tecniverca.pt



Van Heck - Interpieces N.V.
Havendoklaan 14
BE-1804 Vilvoorde
Tel: +32 (0)2 255 84 50
Fax: +32 (0)2 255 84 59
Internet: www.vhnp.be



Workshop Direct
Unit 4, Lakelands Enterprise Centre
IE-Ballydangan, Athlone, Co. Roscommon
Tel: +353 90 9673232
Fax: +353 90 9673104
E-Mail: info@workshopdirect.ie
Internet: www.workshopdirect.ie



KRAFTWERK IBERICA S.L.
C/De las Vacas, no. 6, oficina 5
ES-28341 Valdemoro (Madrid)
Tel: +34 91 809 22 97
Fax: +34 91 809 49 33
E-Mail: kraftwerk@futurnet.es



KRAFTWERK Särl.
25, rue du Stade
F-67870 Bischoffsheim
Tel: +33 388 48 64 50
Fax: +33 388 50 27 32
E-Mail: info@kraftwerk.fr
Internet: www.kraftwerk.eu



KRAFTWERK Europe AG
Mettlenbachstrasse 23
CH-8617 Mönchaltorf
Tel: +41 44 949 40 50
Fax: +41 44 948 11 58
E-Mail: info@kraftwerk.ch
Internet: www.kraftwerk.ch